

alfitec W73 Einbaumöglichkeiten

Rahmenlos

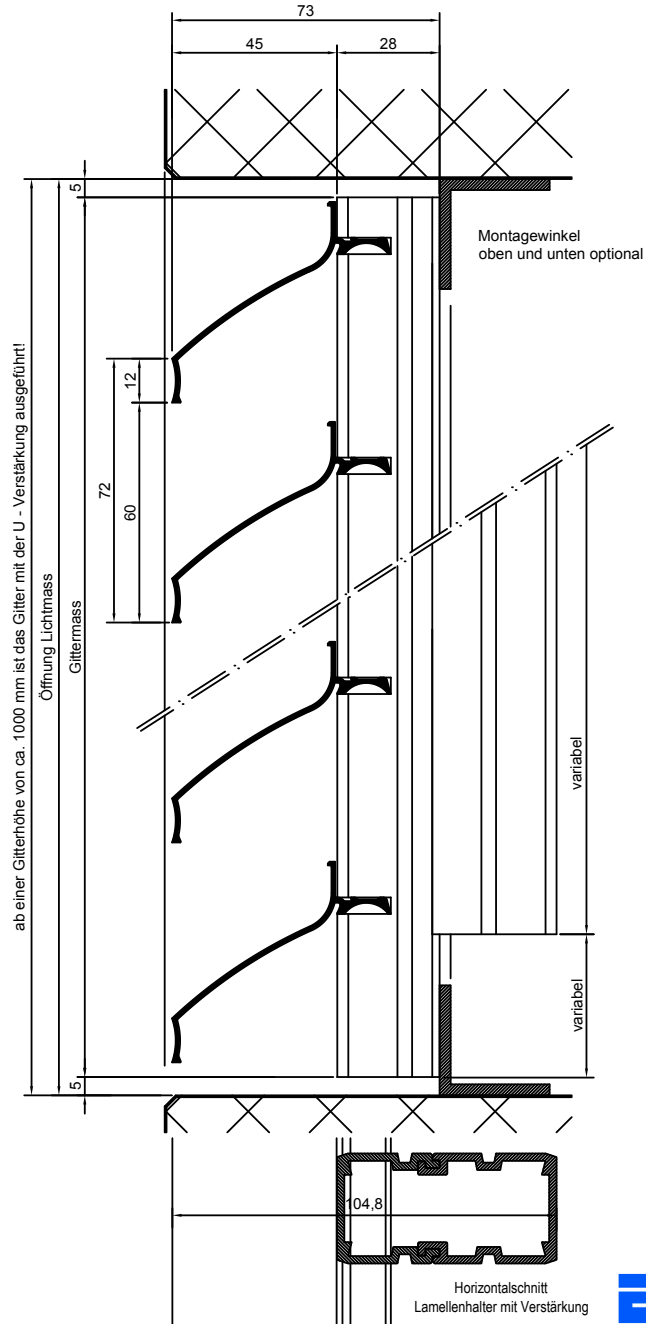

L - Rahmen

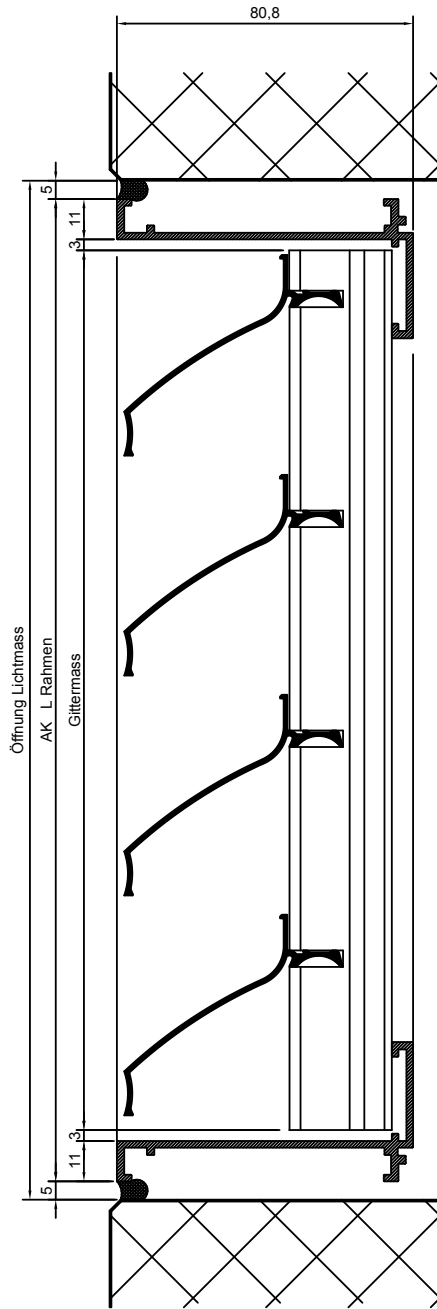

Z - Rahmen

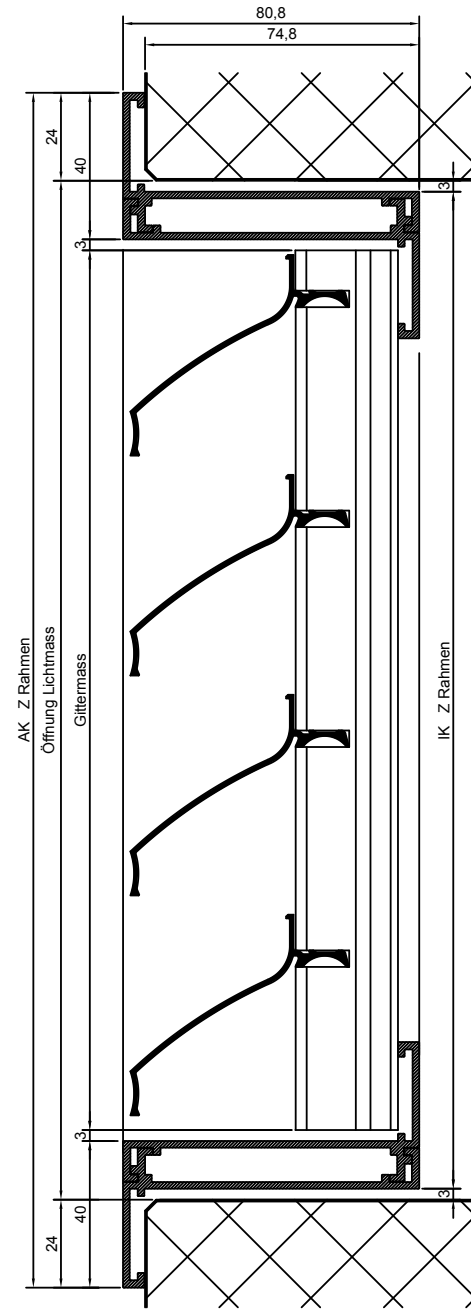

HORIZONTALSCHNITT alfitec W73

OPTION
LAMELLENHALTER mit VERSTÄRKUNG

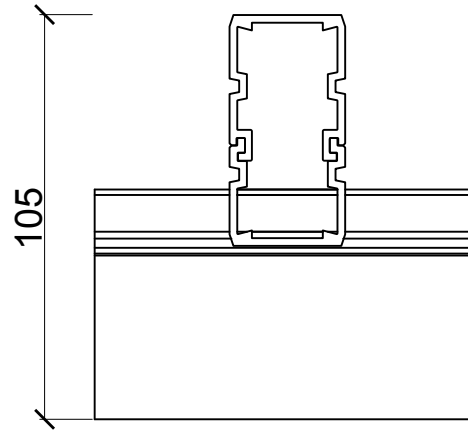

OPTION
LAMELLENHALTER mit Deckel

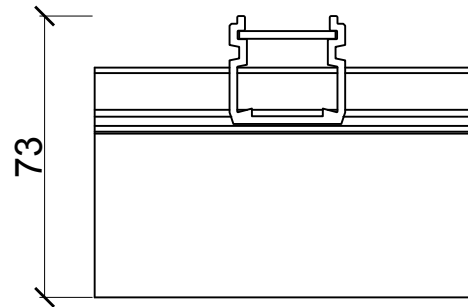

LAMELLENHALTER standard

