

alfitec L38 Einbaumöglichkeiten

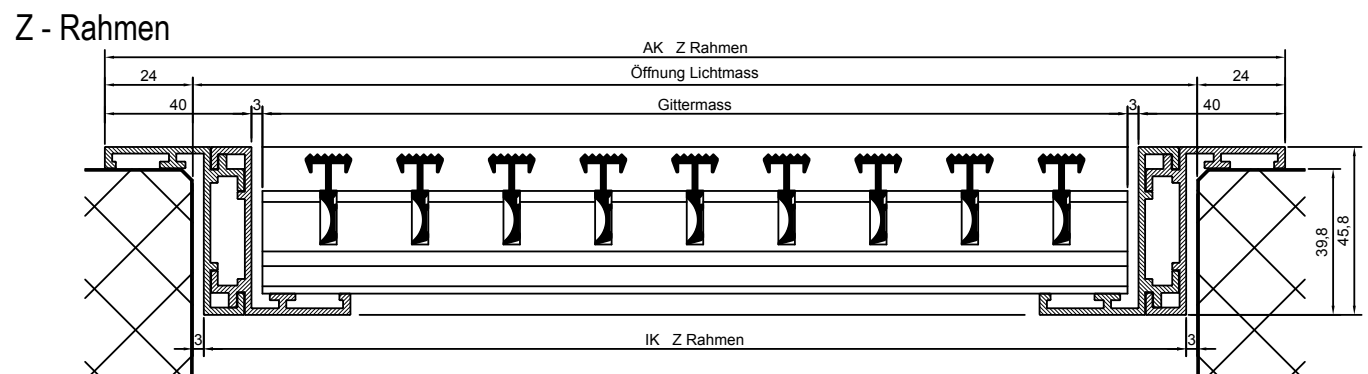

HORIZONTALSCHNITTE alfitec L38

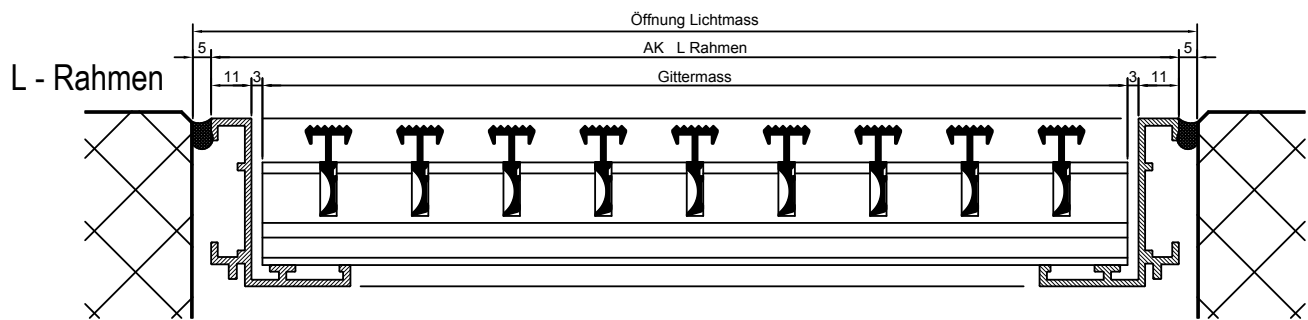
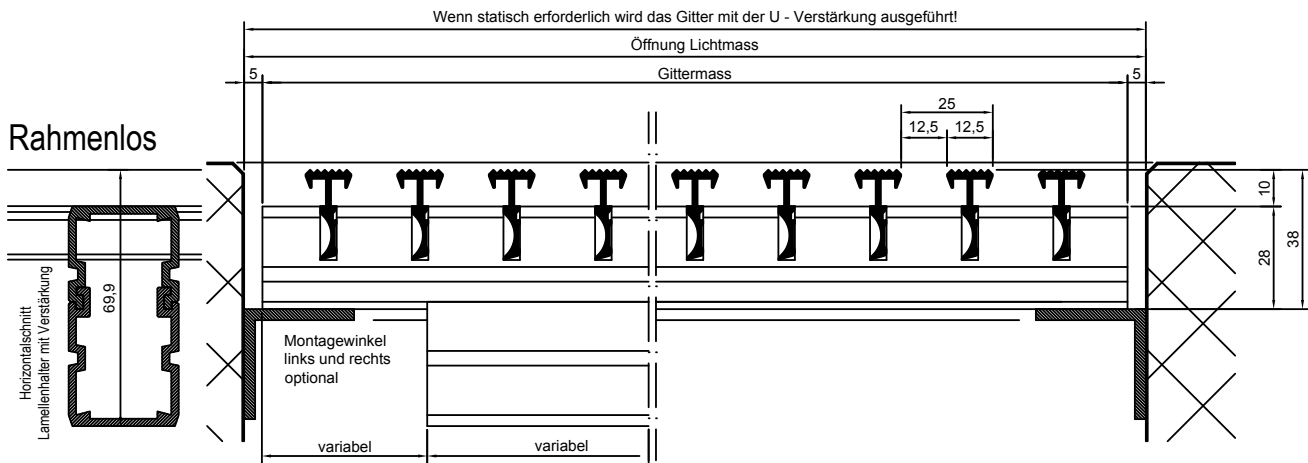
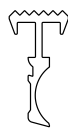
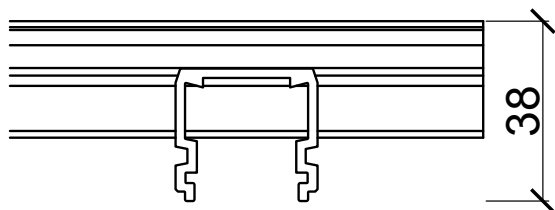

LAMELLENHALTER standard

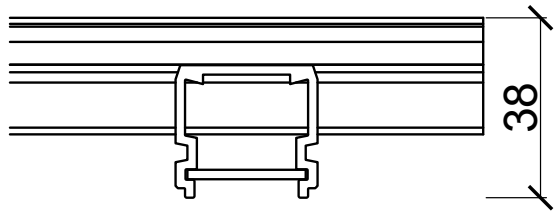

OPTION
LAMELLENHALTER mit Deckel

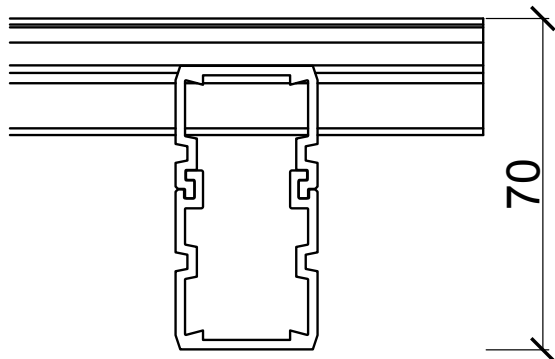

OPTION
Lamellenhalter mit VERSTÄRKUNG